



VM - VASOVIĆ
VRATA I PANELI



■ ULAZNA ALUMINIJUMSKA VRATA



Perfekcija je na dohvat ruke

Ulazna vrata – zar nisu jedan od najvažnijih delova našeg doma? Ona nas štite od hladnoće, kiše ili provalnika, da navedemo samo neke primere. Vrata nas takođe štite od buke sa ulice. Ali kako napraviti pravi izbor i kupiti vrata koja će ispuniti naša očekivanja i služiti nam godinama?

Ispune panela ugrađuju se na krila vrata, tako da se krilo ne vidi i sami paneli dolaze u ravni sa štokom, Zasnovana na sistemu 85 i dostupne su u različitim bojama i strukturama. Elementi se mogu glodati, dekorisati umetcima ili izraditi od termoizolacionog stakla. Panelna vrata mogu se izrađivati u velikim dimenzijama – do 1,30 m širine i skoro 2,60 m visine. Ako, dakle, sanjamo o impresivnom ulazu, ovo je savršen izbor. Ipak, pre svega, vrata treba da se uklope u stil vašeg doma. Ako je enterijer tradicionalan, treba se odlučiti za krilo sa staklenim panelima ili dekorom u imitaciji drveta. Ljubitelji modernog enterijera mogu birati između RAL boja, na primer u nijansi grafitu.

Odvojimo vreme i izaberimo vrata pomoću kojih ćemo stvoriti prelep ulaz koji će oduševiti naše goste i učiniti da se osećamo kao u sigurnom utočištu.

PIVOT VRATA

$$U_D \geq 0.86 \text{ W/m}^2\text{K}$$

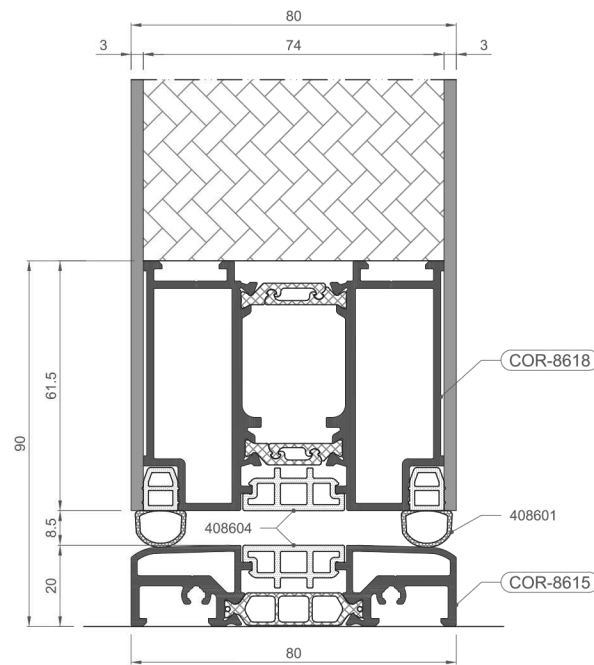

Tehnički detalji:

Dubina štoka	80mm
Dubina krila:	80mm
Maksimalne dimenzije:	Width (L) = 2,100 (1,700* + 400 mm) Height (H) = 3,000 mm

Tehnički parametri:

Propusnost vazduha	(UNE-EN 12207): Klasa 4
Vodonepropusnost	(UNE-EN 12208): Klasa 5A
Otpornost na opterećenje vetrom	(UNE-EN 12210): Klasa C5
Termalna propusnost	UD \geq 0.86 (W/m ² K)
Protiv provalnost	RC2

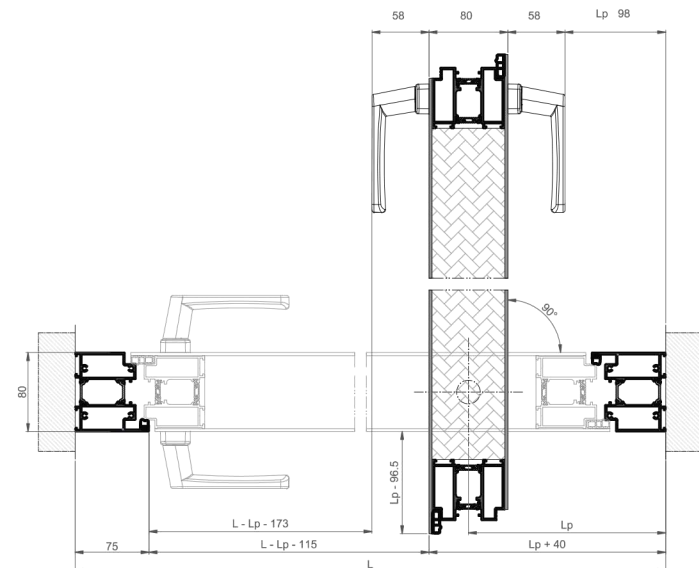



VRATA SA SKRIVENIM KRILOM

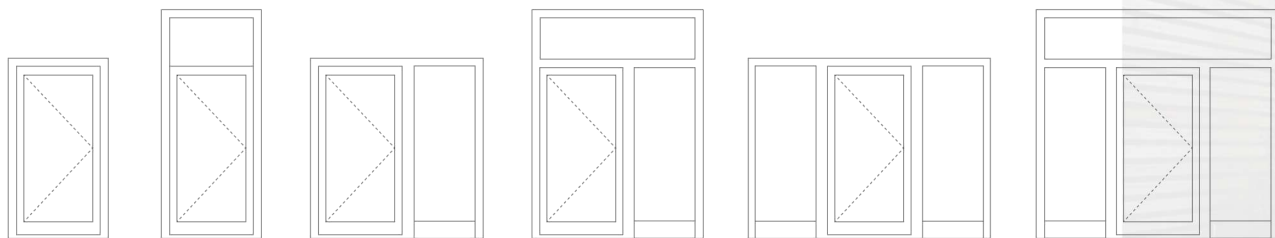
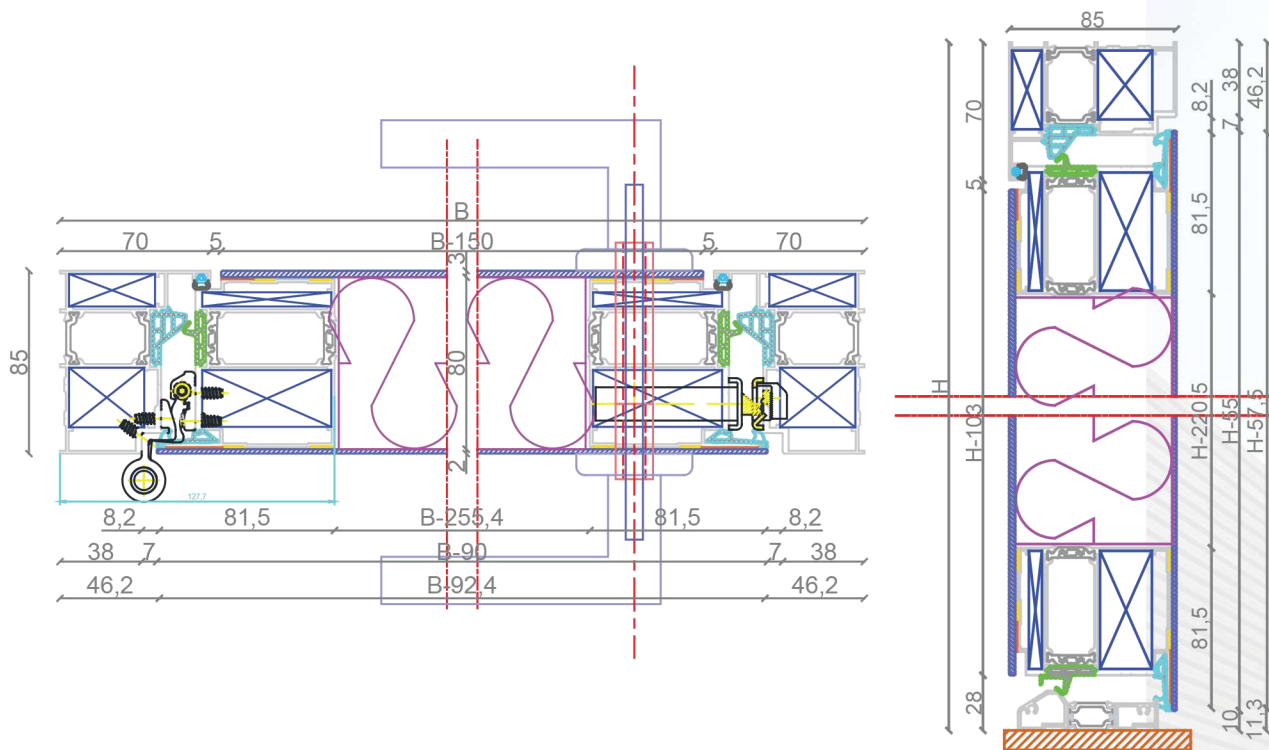



Ulazna vrata nisu samo prolaz – ona su prvi utisak o vašem domu. Kvalitetna vrata spajaju vrhunski dizajn, preciznu izradu i dugotrajne materijale koji garantuju sigurnost, energetska efikasnost i otpornost na sve vremenske uslove.

Estetika se vidi u svakom detalju – od savršeno obrađenih površina i modernih linija, do pažljivo biranog stakla i okova. Kvalitet se oseća pri svakom otvaranju: stabilnost, tiho zatvaranje i sigurnost koja uliva poverenje.

Dobra ulazna vrata nisu trošak – ona su investicija u sigurnost, komfor i prestiž vašeg doma.





Dr. Hahn

Prečnik valjka od 20 mm zadovoljava visoke zahteve graditelja i arhitekata za diskretnim izgledom šarki na kući i objektnim vratima.

Podešljiva je u šest smerova. Podešavanje se odvija unutar šarke. Čak i kod ekstremnog podešavanja, zadržava se prvobitna lepa kontura šarke. Te u velikoj meri predmontirane šarke se mogu brzo i lako ugraditi.

Jednodelna osovina od nerđajućeg čelika osigurava visoku stabilnost. Ova je konstruisana tako da se krila vrata mogu lako ukloniti. Izvrstan kvalitet čaure, od visokokvalitetnog posebnog materijala, ne zahteva održavanje, ni kod vrlo visokih težina vrata i visokih frekvencija ulazaka, i gotovo je bez trošenja materijala.



Pogonska ručica proizvedena je od legure aluminijuma i legure cinka livenjem pod visokim pritiskom. Plastični delovi su od poliamida. Zavrtnji su od ugljeničnog pocinkovanog čelika.



MACO Protect brava s pogonom preko cilindra – fleksibilna i sigurna

Sigurnost s trostrukim zaključavanjem:

MACO Protect Z-TS brava toliko je sigurna da je od strane nemačke policije uvrštena kao prva na popis protivprovalnih proizvoda. Pritom omogućuje kombiniranu primenu kljunova, klinova ili sigurnosnih zatvarača.

Na taj se način povećava protivprovalna zaštita sve do veličine RC3.

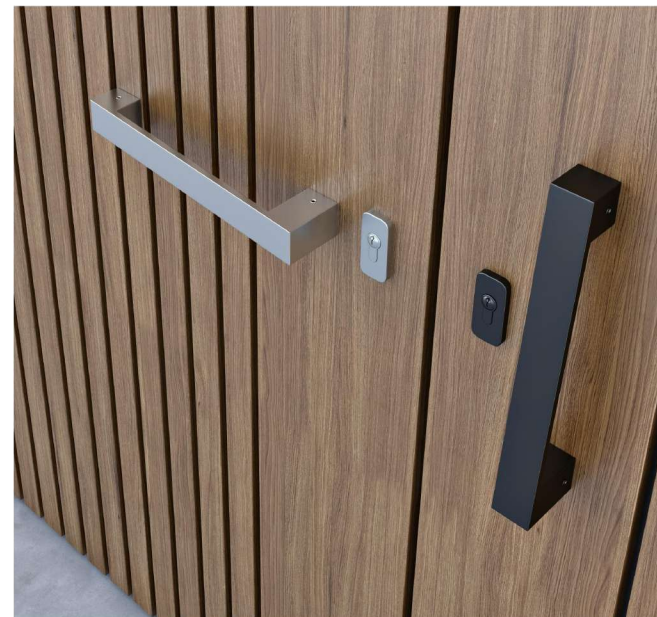
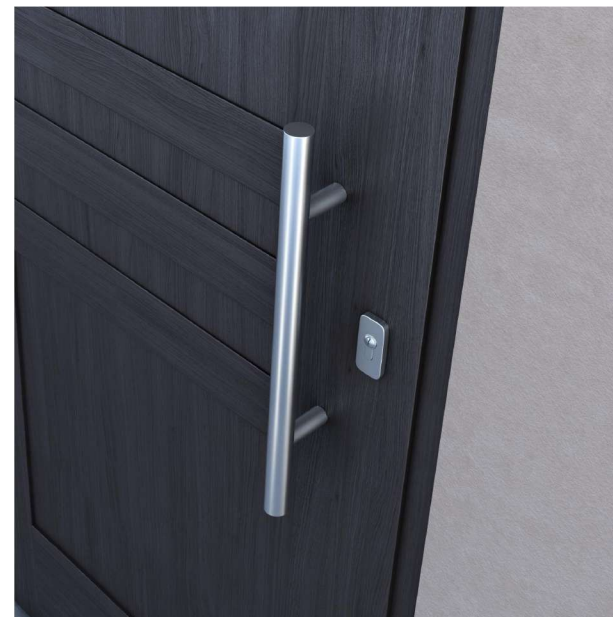

KONTROLA PRISTUPA - OTKLJUČAVANJE NA OTISAK PRSTA

ekey dLine fingerprint scanner

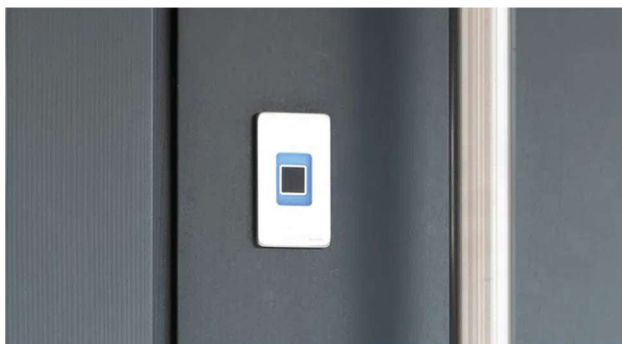
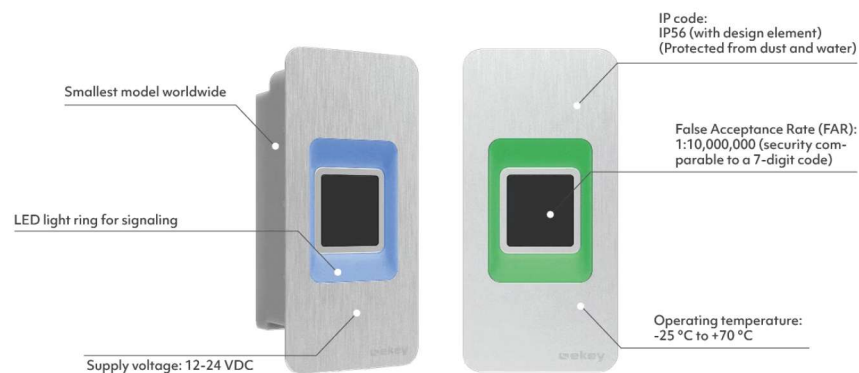

E-key finger print sistem predstavlja savremeno i izuzetno pouzdano rešenje za kontrolu pristupa. Otključavanje vrata vrši se putem otiska prsta, što znači da nema ključeva, kartica niti šifri koje mogu da se izgube ili zloupotrebe.

Sistem prepoznaje jedinstveni biometrijski podatak korisnika za manje od sekunde, pružajući visok nivo sigurnosti i jednostavnosti korišćenja. Idealan je za porodične kuće i moderne objekte jer kombinuje vrhunsku tehnologiju, dugotrajnost i maksimalan komfor pri svakodnevnoj upotrebi.

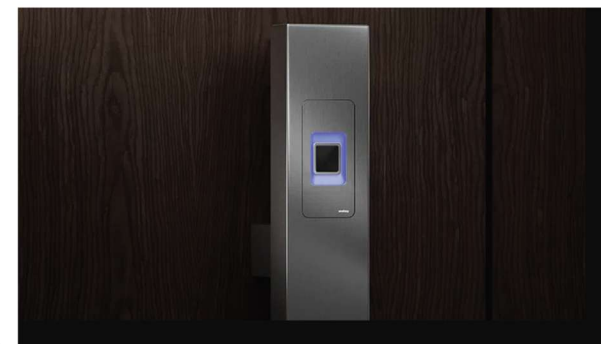

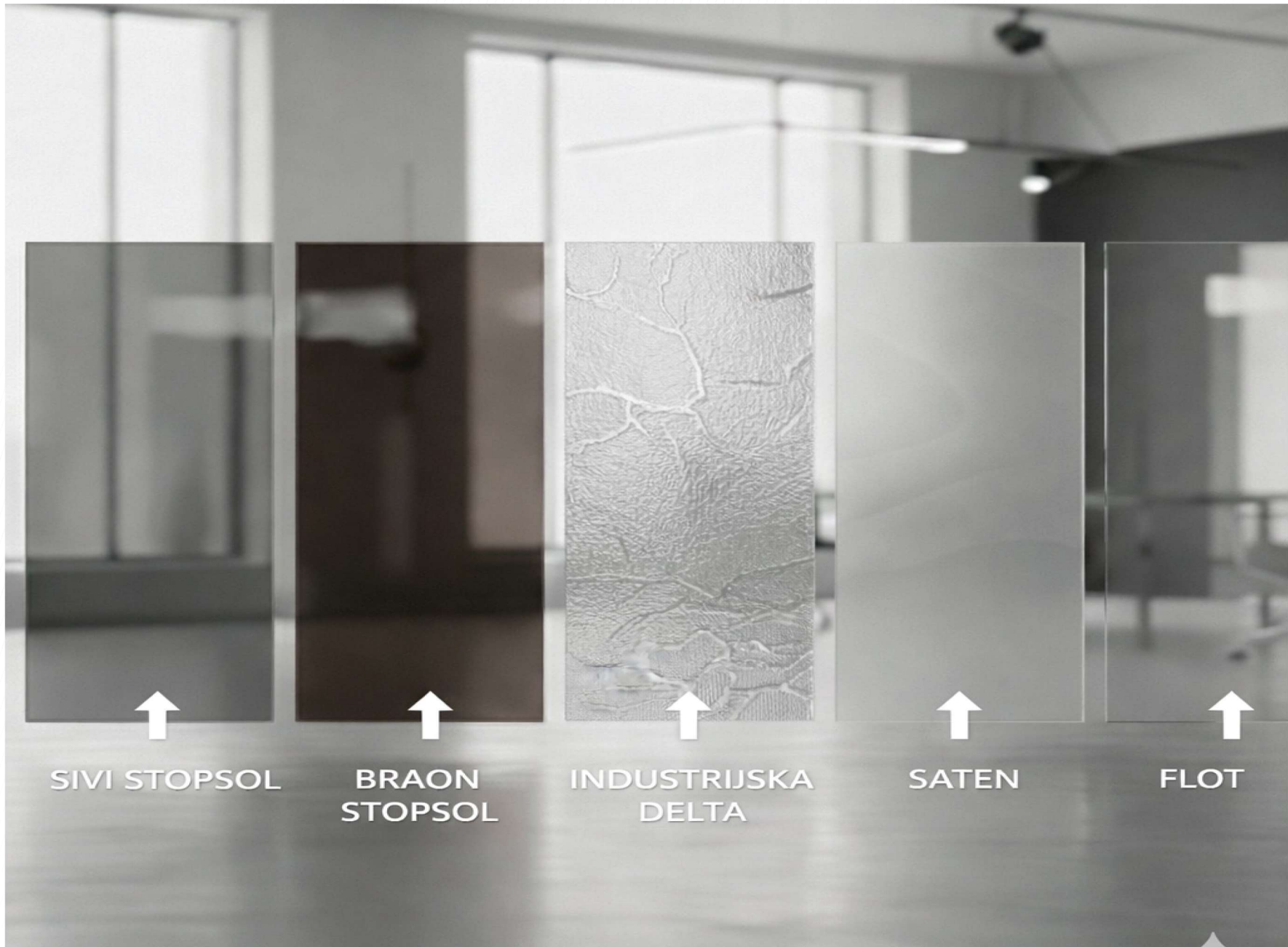

SIVI STOPSOL

BRAON
STOPSOL

INDUSTRIJSKA
DELTA

SATEN

FLOT



9016 sjaj



7016 Antracit mat



9005 mat



8014 sjaj



9006 mat



7021 fina struktura



8019 mat



DB 703



Vrata su dostupna i u dekoru drveta, sa prirodnim izgledom i autentičnom teksturom. Kombinuju toplinu drveta sa dugotrajnošću i otpornošću moderne izrade.





PREMIUM - 1

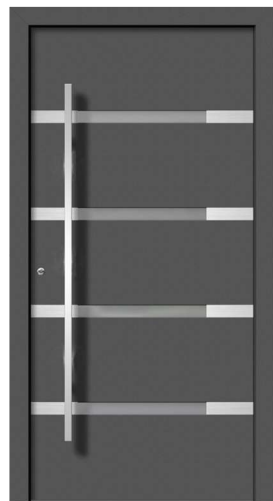

PREMIUM - 2



PREMIUM - 3



PREMIUM - 4



PREMIUM - 5



PREMIUM - 6



PREMIUM - 7



PREMIUM - 8



PREMIUM - 9



PREMIUM - 10



PREMIUM - 11



PREMIUM - 12



PREMIUM - 13



PREMIUM - 14



PREMIUM - 15



PREMIUM - 16

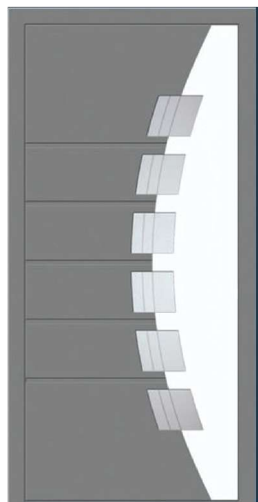

PREMIUM - 17



PREMIUM - 18



PREMIUM - 19



PREMIUM - 20



PREMIUM - 21



PREMIUM - 22



PREMIUM - 23



PREMIUM - 24



PREMIUM - 25



PREMIUM - 26

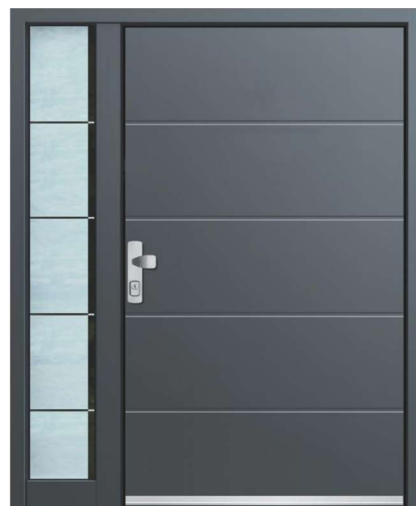

PREMIUM - 27



PREMIUM - 28

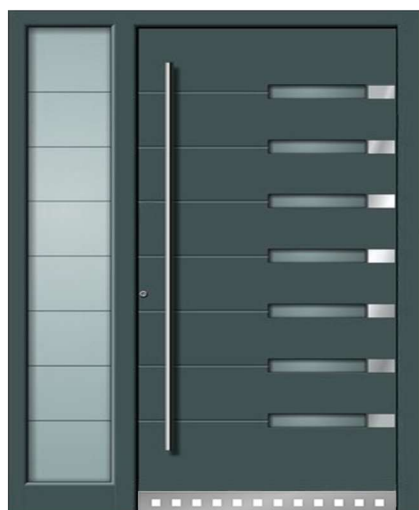

PREMIUM - 29



PREMIUM - 30



PREMIUM - 31

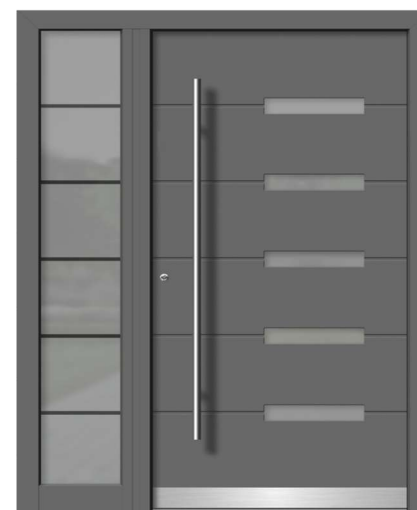

PREMIUM - 32





INOX - 101



INOX - 102



INOX - 103



INOX - 104



INOX - 105



INOX - 106



INOX - 107



INOX - 108



INOX - 109



INOX - 110

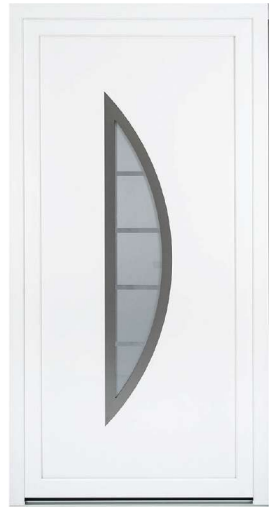

INOX - 111



INOX - 112



INOX - 113

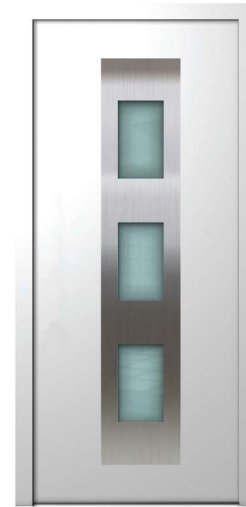

INOX - 114



INOX - 115



INOX - 116



INOX - 117





E - 1001



E - 1002



E - 1003



E - 1004/1

E - 1004



E - 1005

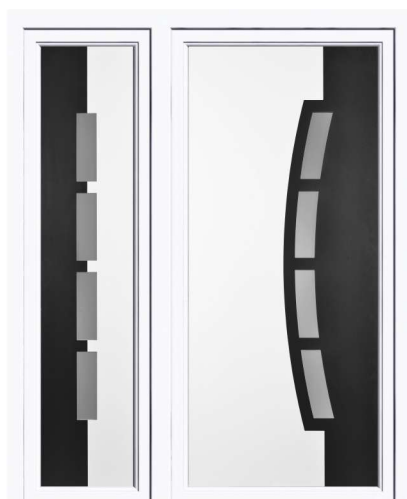

E - 1006/1

E - 1006



E - 1007

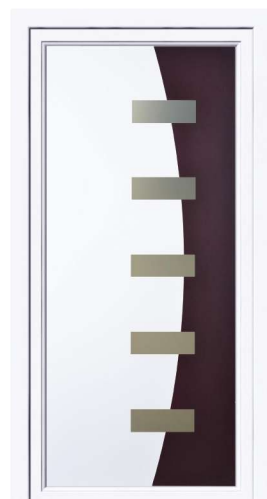

E - 1008



E - 1009



E - 1010

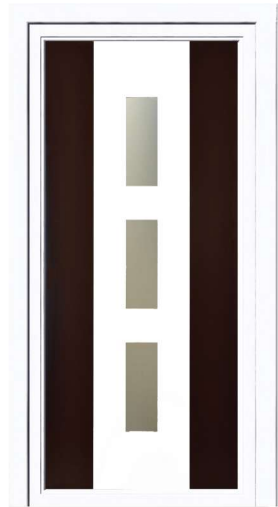

E-1011

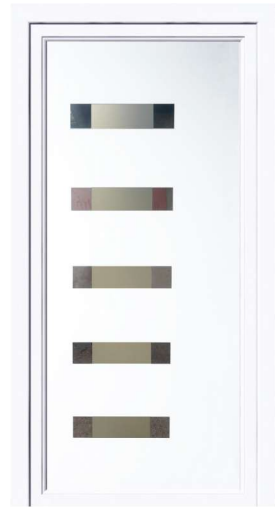

E-1012



E-1013



E-1014

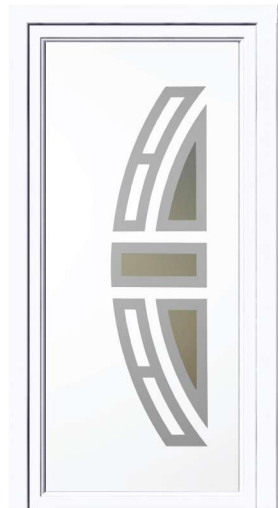

E-1015

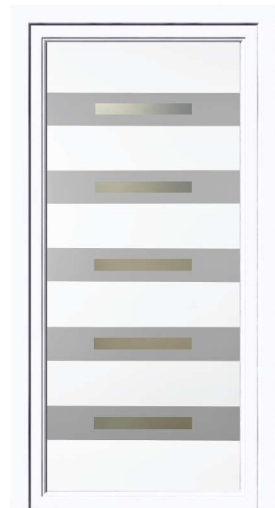

E-1016

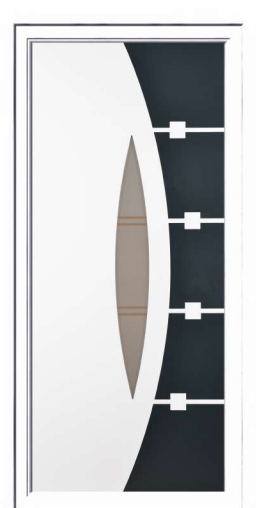

E-1017



E-1018





PV-02/1

PV-02



PV-05/1

PV-05



PV-06/1

PV-06



PV-09/1

PV-09



PV-10/1

PV-10



PV-11/1

PV-11

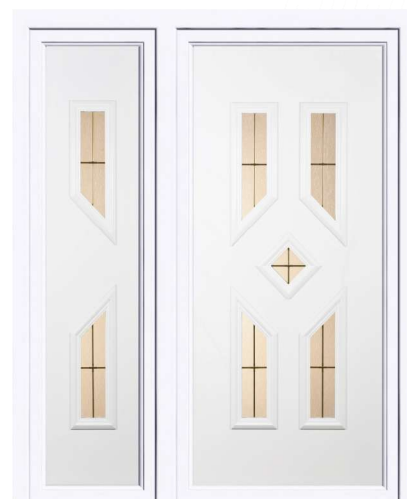

PV-13/1

PV-13



PV-14/1

PV-14



PV-16/1

PV-16



PV-17/1

PV-17



PV-20

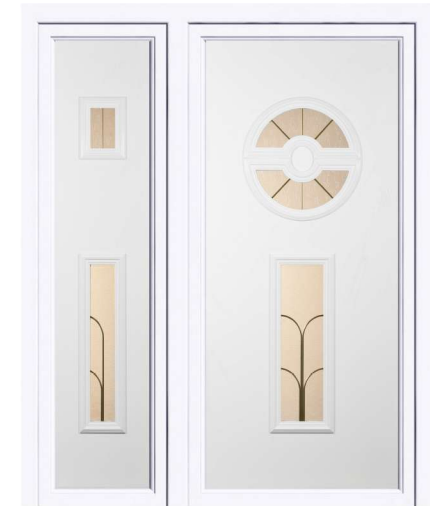

PV-21/1

PV-21



PV-25/1

PV-25



PV-28



PV-32



PV-33

PVC PANELI – S i M MODELİ





PVCS-1



PVCS-2



PVCS-3



PVCS-4



PVCS-5



PVCS-6



PVCS-1 INOX



PVCS-2 INOX



PVCS-3 INOX



PVCS-4 INOX



PVCS-5 INOX



PVCS-6 INOX



PVCM-1/1 PVCM-1



PVCM-2/1 PVCM-2



PVCM-3/1 PVCM-3



PVCM-4/1 PVCM-4



PVCM-5/1 PVCM-5



PVCM-6/1 PVCM-6



PVCM-7/1 PVCM-7

Savršen izbor za one koji biraju tišinu,
prostor i prirodno okruženje.



Diskretno integrisan skriveni rukohvat sa
precizno obrađenim detaljima



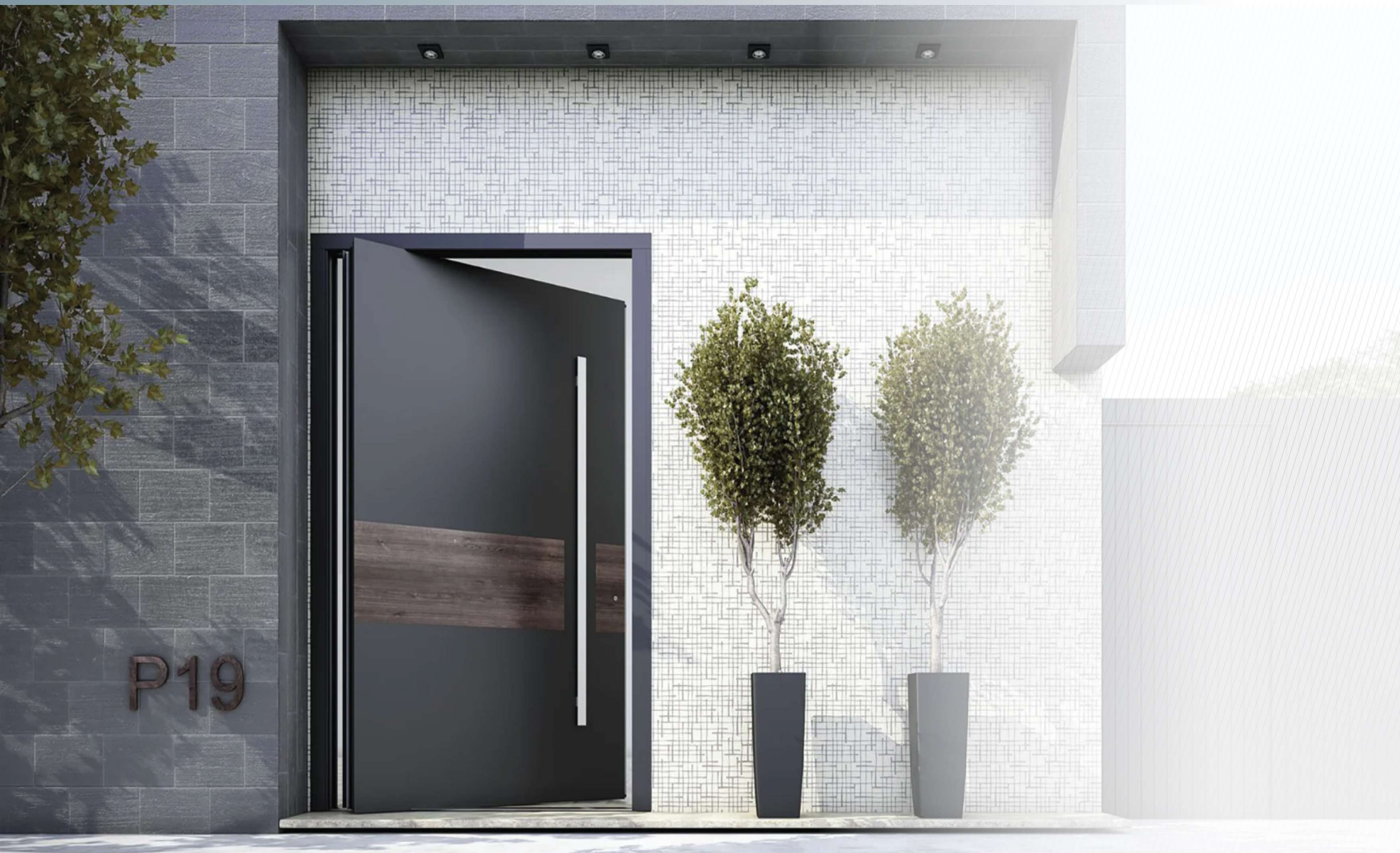



VM - VASOVIĆ
VRATA I PANELI

VM - VASOVIĆ
ALUMINIJUMSKA ULAZNA VRATA I PANELI

ADRESA: STANOJA TODORVIĆA 8a, 11426 MELJAK, BEOGRAD

E-mail: vmvasovic@gmail.com

TELEFON: 064/133-13-16

vmvasovic.rs